

ARAX - 88

MEDIUM FORMAT CAMERA

INSTRUCTIONS FOR USE



1. GENERAL NOTES

The ARAX is a medium-format single lens reflex (SLR) camera with either an all-metal (gold or black) or light-tight rubberized fabric curtain shutter and interchangeable film magazines (sizes: 6x6 or 6x4.5 cm). The camera is designed to meet the needs of any photographer, from the advanced amateur to the working professional.

The ARAX cameras are hand selected KIEV-88s that undergo an extensive mechanical upgrade process. These camera bodies and magazines are re-assembled, adjusted, tested, and matched to provide superior accuracy and to assure a light tight fit between the magazine backs and camera bodies. Any deficiencies in the basic Kiev design are addressed via reinforcement and/or replacement.

The camera is designed to use 61.5-mm wide non-perforated roll film (type 120/220). The camera's curtain shutter offers exposure times over a range from 1/1000 to 1/2 sec. and manual exposure "B". The shutter cocking mechanism and the film transport mechanism are interlocked, thus preventing unintentional double exposures.

The camera comes complete with the MC ARSAT 2.8/80 "standard" lens. The lens is provided with a special multi-layer antireflection coating (MC = Multi - Coating), which upgrades the image quality and enhances its contrast due to better-integrated transparency and reduced light dispersion. The focal length of the lens is 80 mm, the relative aperture is 1:2.8, the diaphragm setting limits are f2.8 - f22, and the near focusing limit is 0.6 m.

Critical focusing is accomplished with the aid of a micro-raster or a range finder wedge arranged in the center of the field of view and with the aid of a ground-glass surface.

The camera is designed to use most interchangeable lenses fitted with a "Pentacon Six" type bayonet mount. The hood-type viewfinder enables the image to be viewed on the ground-glass surface either with or without a magnifying lens. The field of vision of the hood-type viewfinder measures 53x53 mm. Magnification of the TTL (Through the Lens) prism finder eyepiece is 3x, the field of vision measures 53x53 mm.

The camera operates with interchangeable film magazines, which provide either 12 exposures of 6x6 cm size or 16 exposures of 6x4.5 cm size on type 120 film, or 24 exposures of 6x6 cm size on type 220 film. The interchangeable film backs offer the ability to change film types at any time, even in mid-roll.

The camera is provided with flash synchronization compatible with both cabled and hot-shoe flash units.

The camera operates in the temperature range from minus 15 to plus 45° C.

IMPORTANT!

Before starting to use your new ARAX camera, be sure that you have read and understand this manual, preferably with the camera in front of you. You will then be ready to load your film and begin making great photographs. Congratulations on your purchase, and welcome to the ARAX family!

2. MAIN UNITS AND PARTS

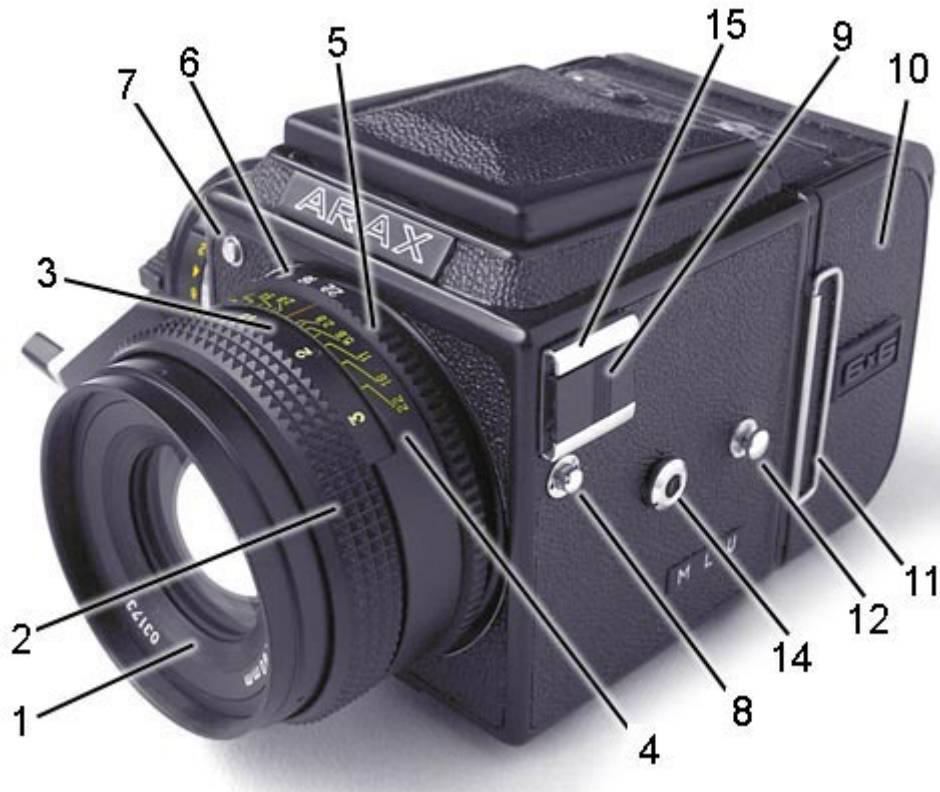

- | | |
|--|---|
| 1 - lens | 15 - flash hot shoe mount |
| 2 - lens focusing ring | 16 - film magazine lock button |
| 3 - distance scale | 17 - exposure scale index |
| 4 - depth-of-field scale | 18 - finder hood |
| 5 - diaphragm ring | 19 - rapid wind crank handle |
| 6 - diaphragm scale | 20 - depth-of-field visual check lever |
| 7 - MLU release button | 21 - exposure scale |
| 8 - bayonet clamping button | 22 - shutter release button |
| 9 - hot shoe cover | 23 - shutter cocking and exposure time setting knob |
| 10 - film magazine | 24 - shutter cocking indicator window |
| 11 - dark slide | 25 - film exposure indicator window |
| 12 - strap fitting eye | 26 - exposure counter window |
| 13 - tripod socket and guide of attaching handle | 27 - multiple exposure release |
| 14 - flash sync plug socket | |





3. OPERATING PROCEDURE

3.1. Preparing the Camera for Loading

Take the camera out of the case. Insert dark slide 11 as far as it will go. Having displaced button 16 in the direction of the arrow, remove it from the camera.

NOTE: The film magazine lock will open only with the dark slide pushed home. Never try to dismount the film magazine without the dark slide inserted.

3.2. Film Magazine Loading

The magazine is loaded with the film in daylight (preferably in shade). See below.



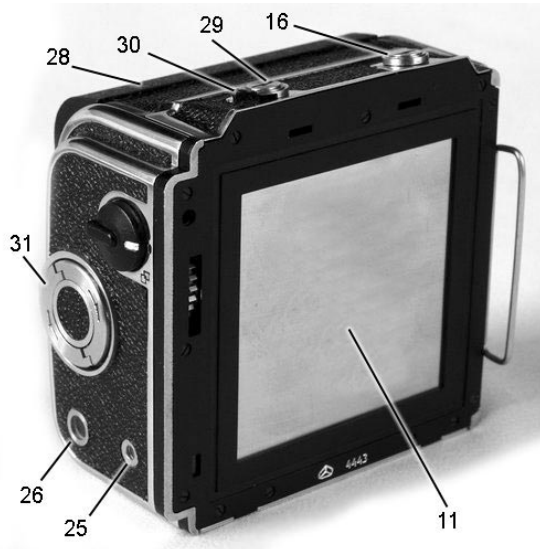

Once the film back has separated from the camera body, you need to open it to insert your film. Remove film magazine cover 28 by first turning little black catch 30 and then shifting metallic button 29 in the direction of the arrows.

Take out transport mechanism 34. Tear off the paper label from the film leader end. Rotate plate 32 through 90°, place the spool with the film into the seat and reset plate 32 to the initial position. In this case the protruding center of the plate should enter the spool hole.

Set plate 33 to the initial position so that the protruding center of the plate will enter the spool hole. Pass the film leader on the guide roller, as shown in the Figure (at the left), fit the leader end in the take-up spool and wind the leader by rotating the take-up spool.

Be sure that the leader will be wound without skewing or crumpling of its edges. Lift one half of knob 31 by turning through 90° and by rotating it in the direction of the arrow set on the leader opposite to the red index on the transport mechanism. Insert dark slide 11 into the seat as far as it will go. Close film magazine cover 28. Turn handle 31 in the direction of the arrow until it stops. The number "1" will show in the exposure counter window 26 which corresponds to the first picture on the roll and the white colour indicator will appear in window 25.

3.3. Preparing the Camera for Shooting

Cock the shutter by turning knob 23 until it stops. Fit loaded magazine 10 on the camera catches and press the top of the magazine towards the camera until the latch clicks. When installing the film magazine with a partially exposed film, be sure that the colour of signals in windows 24 and 25 match, otherwise a double exposure or a blank frame will occur. The state of film transport vs. shutter cocking is displayed by the colour of signals in these windows (ref. to the Table).

Signal colour	Window in the film magazine	Window in the camera
White	Film in the picture window has NOT been exposed	Shutter cocked
Red	Film in the picture window has been exposed	Shutter released

NOTE: It may turn out that some magazines cannot be inserted in the camera's seat (i.e. their sizes do not match accurately to the size of the camera). This happens with magazines which were manufactured without proper quality control.

Please remember that the correct, high quality operation of the camera is guaranteed ONLY if you use the magazines of the original manufacturer (in this case ARAX). DO NOT ATTEMPT TO USE ARAX magazines on Hasselblad cameras and DO NOT USE Hasselblad magazines on ARAX cameras!

3.4. Shooting

The operation of the camera breaks down into the following steps:

1. Shutter cocking and film transport
2. Shutter speed setting
3. Aperture setting
4. Composition
5. Focusing
6. Mirror lock up release (optional)
7. Shutter release

Cock the shutter and advance the film by turning knob 23 all the way. It is absolutely necessary to avoid incomplete cocking. At the beginning of the shutter cocking a slight increase of the force applied to the knob may be required. Always wind the shutter cocking / film advance knob or crank fully, by turning it clockwise until it locks. You must hear a noticeable click when the lock engages.

When the shutter is being cocked:

- the film is automatically advanced;
- the next frame number is set in window 26;
- the white signals are set in windows 24 and 25;
- the mirror is lowered to the viewing position;
- the lens diaphragm aperture is fully opened.

Set the shutter speed with knob 23 when the shutter is cocked. Pull the knob and turn it in any direction until the exposure time value on scale 21 coincides with index 17 arranged on the camera body. Lower the knob in this position so that it locks.

NOTE: Never change the shutter speed without having the shutter cocked first! Never change the shutter speed after MLU realizing!

Set the lens diaphragm by turning ring 6 with scale until the chosen diaphragm aperture value coincides with the index. The scale is fixed on all marked divisions of apertures.

Open the finder hood 18 for viewing by sliding button 37 in the direction of the arrow. With another slide of the button, the viewfinder magnifying lens 35 flips up to the operating position.

If the film magazine for the 6x4.5 cm frame size is attached to the camera, the composition should be framed by the thickened lines in the finder's field of view.

Focus the camera with the aid of the ground-glass surface with a micro-raster and a rangefinder wedge or with the aid of the distance scale by turning focusing ring 2 with the scale. The focusing is to be carried out only with the shutter cocked when the mirror is in the working position and the diaphragm is fully opened. The depth of field is determined with the aid of the distance scale 3 by means of additional scale 4.



The depth of field can be previewed on the ground-glass surface in the field of view of the viewfinder by pressing lever 20 fully downward. In this case the lens is stopped down to the earlier preset value. When released, the lever automatically returns to the initial position and the diaphragm is fully opened.

When both the composition and focusing are complete, remove the dark slide 11 and release the camera shutter by pressing smoothly on release button 22 as far as it will go.

In the cameras equipped with the lifting MLU (mirror lock up) system, before pressing on the release button 22 there is the ability to raise the mirror before releasing the shutter. In order to lift the mirror it is necessary to press the button 7. At that time the mirror will be lifted upwards, however the shutter is not being released. In order to then make an exposure with the mirror up, just press the button 22. The camera will snap into action without the minimal vibrations that can affect the most critically sharp images.

NOTE: Never change the shutter speed after MLU activation! After MLU activation and exposure, you can cock the shutter again, then you can change the shutter speed BEFORE MLU ACTIVATION.

When the camera shutter is being released:

- the mirror automatically swings to the upper position;
- the diaphragm aperture closes to the preset value;
- the film is exposed;
- the red signals are set in windows 24 and 25.

Since the primary tasks of camera operation are possible only with the shutter cocked, please get used to cocking the shutter immediately after each exposure.

At exposure times slower than 1/30 sec. the use of a tripod is recommended.

When using the camera with slow shutter speeds of 1/60th sec. or longer, continue to hold in the shutter release button when making an exposure, to prevent the shutter brake from engaging prematurely, resulting in uneven exposures.

Tripod socket 13 in the camera is provided with a thread size of 3/8".

The camera shutter can be released with a cable release, which is screwed into the threaded hole of the shutter release button.

The NT (New Technology) film magazine has the device, which permits multiple exposures. For this purpose set handle 27 to the position  and cock the shutter of the camera. The handle will return to the initial position after cocking the shutter.

When the shoot is over, fold the finder hood. To do this, press the viewfinder-magnifying lens 35 into cap 18 until it is locked, fold the sidewalls, then the rear wall and while holding the rear wall, close cap 18 until it is fixed by a lock.

4. DETERMINING THE EXPOSURE WITH THE AID OF THE TTL/SPOT PRISM VIEWFINDER

The TTL/SPOT viewfinder provides a direct image of the subject for composition. It also provides accurate shutter speed and aperture values with the aid of its built-in exposure meter. The TTL/SPOT viewfinder has two exposure metering modes: averaging and spot modes. The averaging metering mode provides metering in the brightness range from 2 to 16000 cd/m and the spot mode - from 8 to 16000 cd/m.

The averaging metering is carried out in the central area of the viewfinder field of view. The central area has an oval shape of 30x50 mm in size. The spot metering sensitive zone is in a restricted area of rectangular shape of 5x10 mm in size.

The exposure meter is activated by pressing button 39, (SEE ILLUSTRATION) It operates for about 20 sec. and then automatically turns off. To toggle metering modes it is necessary to press the button once again.

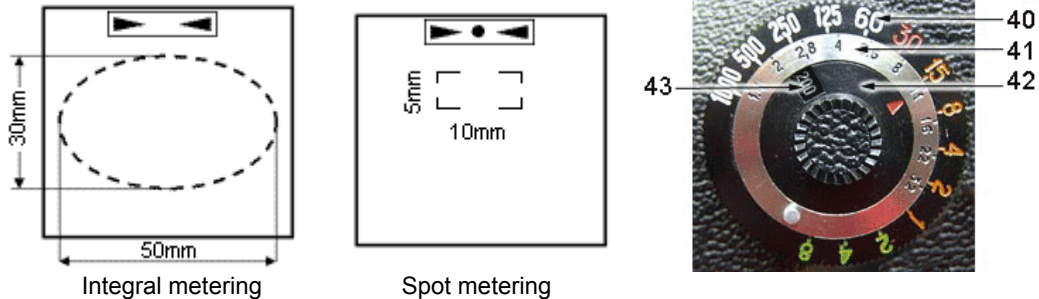

As a power supply the exposure meter requires a battery with an initial voltage of 4-4.5 V (diameter of 11.6 mm, length of 16.2 mm). For example, a source comprising three elements of PX675, RM675 or MS76 types. Or 3pcs 1.5V cells, Ø 11.6mm (SR44, 357, V357, D357, SR44W).

The power supply source ensures the exposure meter operation in the temperature range from minus 5 to 45°C.

When preparing the prism viewfinder for operation set the film sensitivity on its calculator by turning handle 42 until the film speed value in ISO units appears in window 43.

Set on the calculator dial the value of the lens speed by turning scale 41 until the appropriate value coincides with the index.

The lens speed is a number corresponding to the maximum relative aperture. For example, it is 2.8 for MC ARSAT C lens.



The exposure is determined with the camera shutter cocked.

Having pressed the exposure meter circuit actuating button, select the required operating mode (TTL or SPOT).

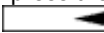
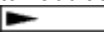
The illumination of the middle signal  means that spot-metering mode is ON. Illumination of the extreme signs indicates that the averaging metering mode is on.

To change the metering mode it is necessary to press the exposure meter actuating button additional times. When the exposure meter is on the "overexposure" indicator  or "underexposure" indicator  is lit.

While observing through the eyepiece, aim the camera at the subject so that its image (or the image area you wish to meter) will be in the limits of viewfinder metering zone.

With the viewfinder button on in the upper part of field of view depending on the subject brightness you will see the illumination of the "overexposure" sign  or "underexposure" sign 

Slowly turning ring 40 of the calculator, achieve simultaneous illumination of both indicators. With the calculator in this position choose the "shutter speed / aperture" combinations required for the correct exposure. For example, exposure 1/30s is opposite diaphragm value 2.8, 1/15s is opposite 4, 1/8s is opposite 5.6, 1/2s is opposite 11. Set the desired exposure and diaphragm values on the camera shutter speed dial and the diaphragm aperture on the tens scale.

Always use eyepiece 44 for the most accurate metering.

NOTE: The eyepiece design makes it possible to employ dioptic lenses. For mounting the dioptic lens it is necessary to unscrew the clamping ring of eyepiece 44, insert the lens of 23 mm in diameter in the mounting seat and secure it with the clamping ring.

5. UNLOADING THE CAMERA

Normal operation continues until the letter "K" (end) appears in the frame counter window indicating that the film has been completely exposed. At this time, fully insert the dark slide 11 and remove the film magazine from the camera having moved button 16 in the direction of the arrow. Using handle 31 rewind the remaining paper leader onto take-up spool (at the end of rewinding the force applied to the handle should be reduced).

Open the film magazine cover 28. Remove transport mechanism 34. Turn plate 33, remove the spool with exposed film and glue the leader with a paper label. Return plate 33 to the initial position, install the transport mechanism 34 into the magazine body and close the cover 28. Or, repeat the operations to load the next roll of film, as desired.

6. REPLACEMENT OF LENSES

The camera is designed to use interchangeable lenses with a Kiev C (P-SIX) mount.

ARAX cameras have a specially designed quarter turn bayonet mount called "Insert and Twist". It allows the use of the full range of interchangeable lenses (Schneider-Kreuznach, Zeiss [including Sonnar 2.8/180], Meyer, Arsenal and others). These range from the 30 mm ARSAT Fisheye right up to the 1000 mm Pentacon.

To remove the lens, press the bayonet release button 8. At that time, the lens-locking device is released. While holding in button 8, turn the lens counterclockwise up to the stop and remove the lens.

When mounting a lens, place it on the camera in such a manner that the guide pin of the lens will enter the slot on the lens mount. Then turn the lens clockwise until you hear a noticeable click of the latch (lock). During mounting there is no need to press the latch button 8. It is important to bear in mind that the lens should be inserted strictly at right angles to the lens mount.

NOTE: The lens mount is a very precise mechanism. It may turn out that some lenses cannot be inserted in the lens mount. This usually happens with lenses, which were manufactured without proper quality control.

These interchangeable ARSAT C lenses for the ARAX and KIEV 88 CM camera are available.

Description, ARSAT C	Focal length, mm	Angle of vision, degrees	Maximum relative aperture	Filter thread, mm
3.5/30	30	180	1:3.5	m38x0.5
3.5/45	45	83	1:3.5	m82x0.75
PCS 3.5/45 Shift	45	83*/98**	1:3.5 (manual)	m82x0.75
PCS 4.5/55 Shift	55	69*/84**	1:4.5 (manual)	m72x0.75
PCS 3.5/65 Shift	65	66*/78**	1:3.5 (manual)	m72x0.75
3.5/65	65	66	1:3.5	m72x0.75
2.8/80	80	45	1:2.8	m62x0.75
2.8/120	120	36	1:2.8	m62x0.75
2.8/150	150	29	1:2.8	m82x0.75
3.5/250	250	19	1:3.5	m82x0.75
5.6/250	250	18	1:5.6	m62x0.75
5.6/500	500	9	1:5.6	m95x1

* - without shift

** - with shift

You can purchase any of this lenses on our website www.araxfoto.com

7. REPLACEMENT OF VIEWFINDER

The ARAX can use interchangeable viewfinders. You can use the following:

- Folding waist-level finder
- Non metering prism finder
- TTL averaging metered prism finder
- Spot/averaging, TTL prism finder

In order to remove the viewfinder from the camera, it is necessary first of all to remove the film magazine 10. Then pull the viewfinder backwards, while holding the camera body and remove the viewfinder. There are no locks holding the viewfinder, just remove it by sliding it backwards. Then any other viewfinder (for example a TTL prism finder) can be installed in its place.

NOTE: It may happen that the viewfinders on brand new cameras are a bit difficult to remove and to insert (a rather tight fit). This is not a defect and it does not affect the operation of the camera.

8. FLASH PHOTOGRAPHY

The ARAX can use most flash systems for which attachment to the camera incorporates a hot shoe in yoke 15 and plug socket 14. This allows you to use flash units with the hot shoe (cable-less connection) and flash units with plug sockets (PC cable connection).

When operating the flash unit the minimum exposure sync speed is 1/30 sec.

Before installing the flash lamp into yoke 15 you have to remove hot shoe cover 9 from the yoke.

9. USE OF LIGHT FILTERS

You can use light filters used as attachments, which can be screwed into the front part of the lens (thread M62x0.75).

The achromatic light filter UV-1x is used for weakening the effect of ultraviolet rays, for example, when taking pictures under high-mountain conditions, it is also helpful in colour photography.

The light yellow-green filter YG-1.4x improves tone reproduction of multi-colour objects on high-sensitive photographic materials with a slight loss of their sensitivity. Virtually correct tone reproduction of multicolor objects is achieved by the use of the filter on medium sensitivity films.

The light filter O-2.8X, orange, fully absorbs Ultraviolet Rays. It is used to obtain a particular contrast in shooting the compositions with clouds, water surfaces, landscapes with a noticeable shading of verdure, etc.

10. REPLACEMENT OF POWER SOURCE

The battery condition is checked by LED signals, which light up in the field of view of finder eyepiece. If the signals are absent with button 39 pressed it means that the batteries need to be replaced.

To replace or install the batteries, unscrew the battery cap on the metering prism, and observing the polarity ("+" of the power supply source should be arranged from the end of the compartment, "-" symbol is engraved on the cap) install the fresh batteries into the chamber. Never try to mix old and new batteries.

Battery for TTL prism viewfinders

Dimension		Volt	Nominal Capacity	Battery models							
Diameter	Height			GP	IEC	JIS	EVEREADY	VARTA	DURACELL	SONY	
11.6mm	5.4mm	1.55V	165mAh	357	SR44	SR44	357	V357	D357	SR44W	

11. CARE AND STORAGE

Protect the camera from dust, moisture, snow, harmful vapors, jerks, jolting, impacts and sharp temperature variations.

Handle the camera with care, excessive force should never be required during operation.

Do not remove the lens unnecessarily since this may result in dirt and dust getting into the camera.

Clean the camera regularly. Remove the dust from its external and internal surfaces with a soft brush or blow off the dust with the aid of a rubber bulb. Thoroughly protect the optical components from getting dusty or dirty, try to avoid touching them with your fingers.

Having brought the camera from the frosty weather into warm premises, do not open it immediately, let it become gradually warmed for 2-3 hours.

Don't leave your camera with cocked shutter for long time.

If any defects or faults have been discovered, do not attempt to carry out the repairs on your own. Qualified specialists should carry out any repairs and adjustments. Please write us at repair@araxfoto.com

NOTE [only crucial while the camera has the mirror up (uncocked shutter or with MLU-function)]:

The camera curtains are made from light-tight rubberized fabric and to preserve it against deterioration the following measures should be taken in shooting in the sun:

- **Remove the lens cap and open the viewfinder hood immediately before shooting;**
- **Do not direct the camera lens towards the sun;**
- **Do not leave the camera in the sun during long-term outage between shootings.**

Version 7 (9-28-2005)



ARAX Inc.
Kiev, Ukraine, 01042
www.araxfoto.com
info@araxfoto.com